

# BACK TO FUTURE

SILVER  
STREAM  
SOARER



PB8802



# Инструкция по использованию УФ-переводных наклеек

УК аудармалы жапсырмаларды пайдалану бойынша нұсқаулық



1. Оторвите соответствующие наклейки и приклейте их на детали.

1. Тиісті жапсырмаларды ажыратып алыңыз және оларды бөлшектерге жабыстырыңыз.



2. Плотно прижмите наклейку к детали.

2. Жапсырманы бөлшекке тығыз басып ұстаңыз.



3. Медленно оторвите пленку от поверхности.

3. Бетінен үлдірін жайымен тартып ажыратыңыз.

Примечание: Наклейки на детали со специальным покрытием следует оставить на 24 часа, прежде чем отрывать.

Ескертпе: Арнайы жабыны бар бөлшектерде үлдірін ажыратып алмас бұрын, жапсырмаларды 24 сағатқа қалдыру қажет.

Примечание: при отрыве, пожалуйста, обратите внимание на то, остался ли рисунок на детали.  
Если нет, то снова приклейте и оторвите пленку с поверхности.

Ескертпе: үлдірін ажыратып алған кезде, суреттің бөлшек бетінде қалған-қалмағанына назар аударыңыз.  
Қалмаған болса, жапсырманы қайтадан жабыстырыңыз және бетінен үлдірін ажыратып алыңыз.

# Инструкция по сборке құрастыру бойынша нұсқаулық

## • Советы по сборке 1

### 1-ші құрастыру жолы бойынша кеңестер

Собирайте в последовательности, указанной на упаковке с номером детали.

Бөлшек нөмірі бар қаптамадағы көрсетілген ретпен құрастырыңыз.



\* Поскольку каждый продукт производится разными подрядчиками, для получения точной информации следует обратиться к самому продукту.

\* Әр өнімді әртүрлі мердігерлер өндіретіндіктен, дәл ақпарат алу үшін өнімнің өзін қараған жөн.

## • Советы по сборке 2

### 2-ші құрастыру жолы бойынша кеңестер

Правильное использование подъемника

Көтергішті дұрыс пайдалану

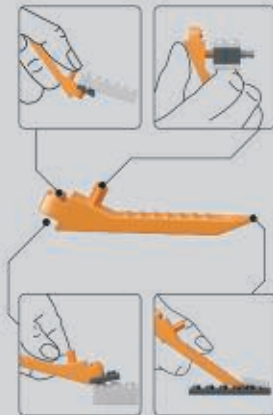

## • Советы по сборке 3

### 3-ші құрастыру жолы бойынша кеңестер

Детали с металлическим блеском помечены в инструкции знаком "X"

Металл жылтыры бар бөлшектер нұсқаулықта "X" таңбасымен белгіленген



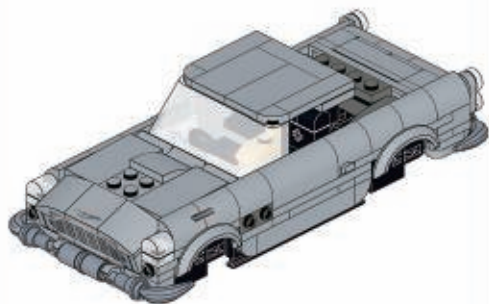

2x

1x



1

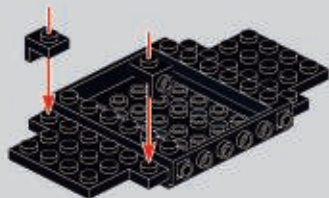



2

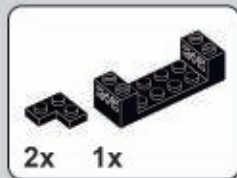
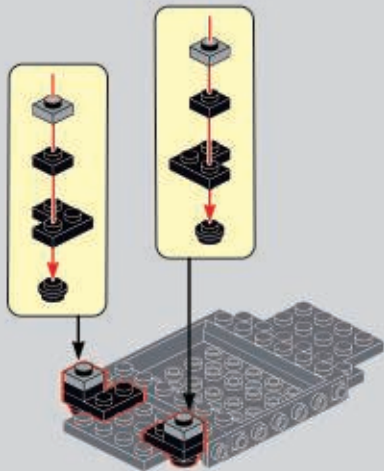

3

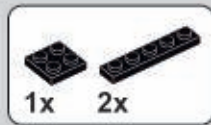
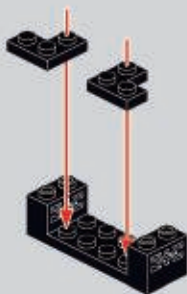

4





5

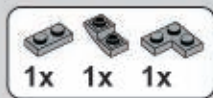
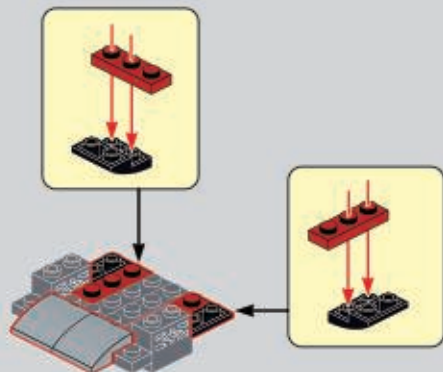

6



7





8



9

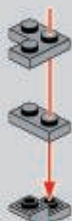

10



11



12

11

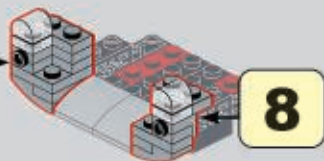

13

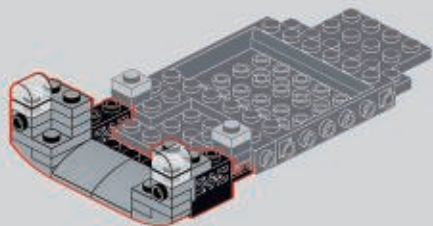



14

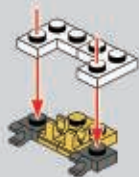

15



16

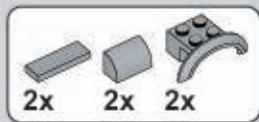
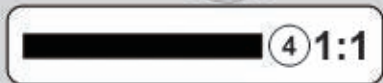
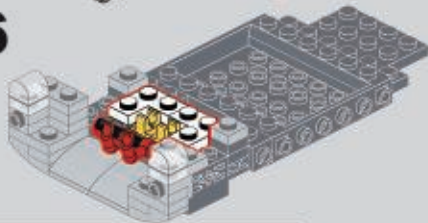

17

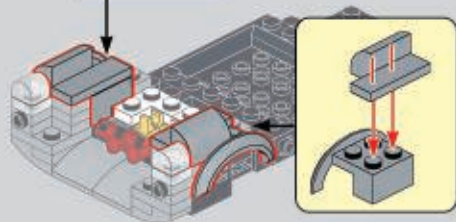
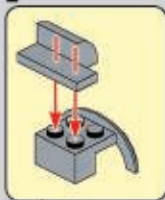



18

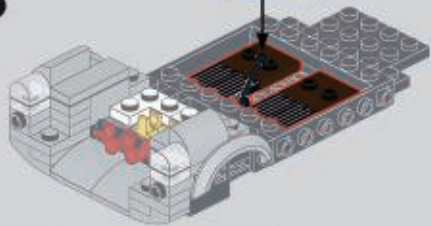

19



20



21

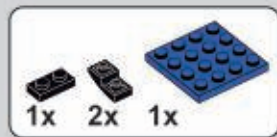
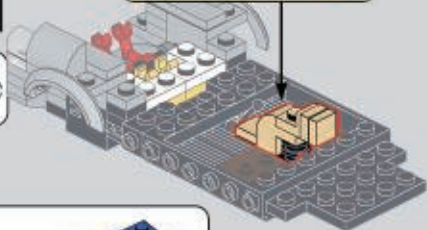
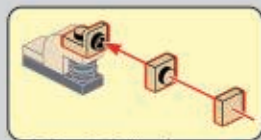

22

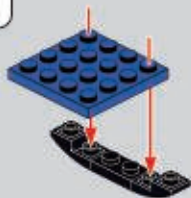



23

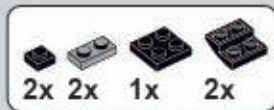
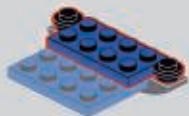

24

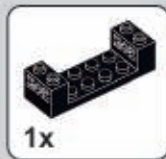
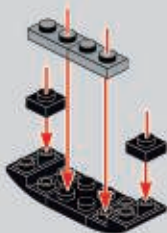

25

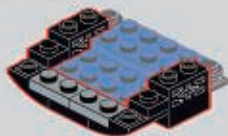

26

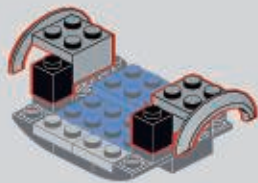

27

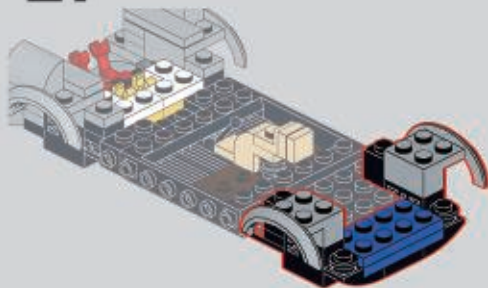



28

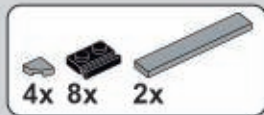
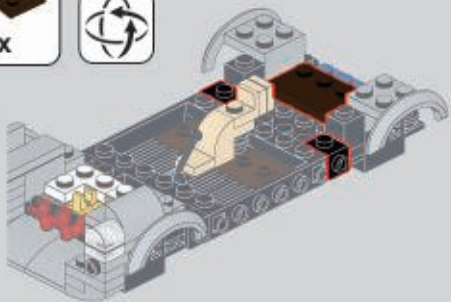

29

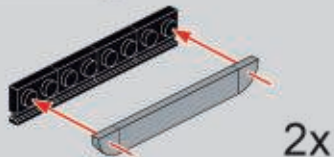

30

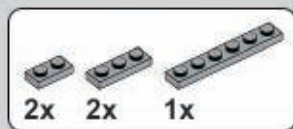
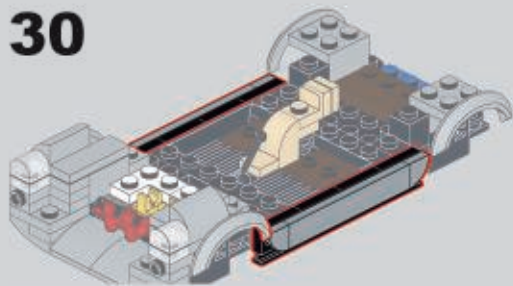

31

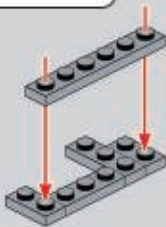

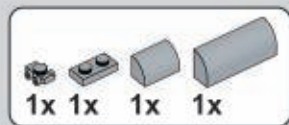

**32**



**33**

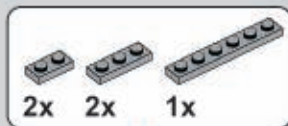

**34**

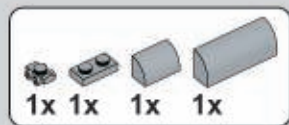
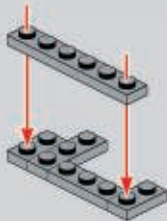

**35**

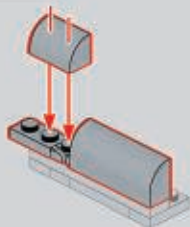

**36**

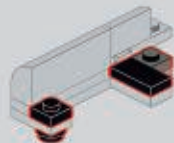

# 37

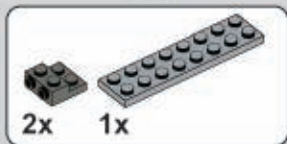
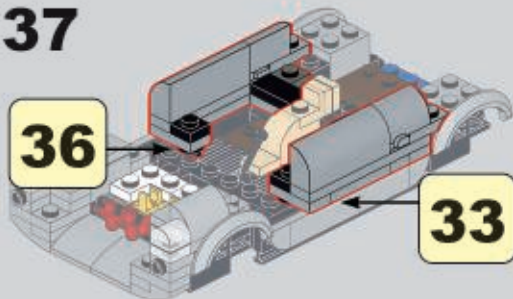

# 38

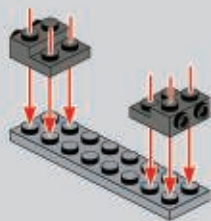

# 39

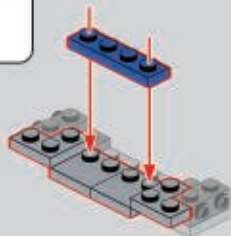

# 40



# 41





42



43

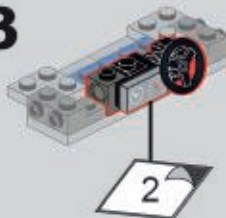

44

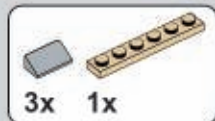
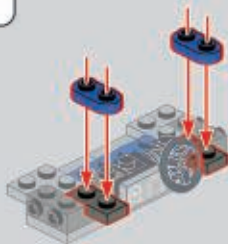

45

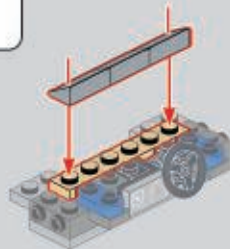

46



# 47

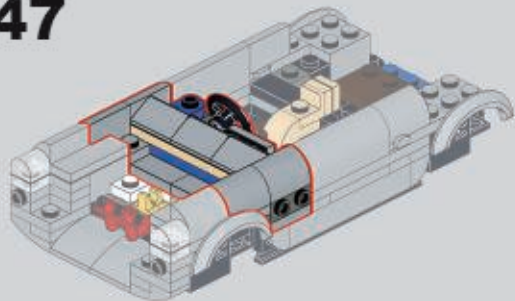

# 48

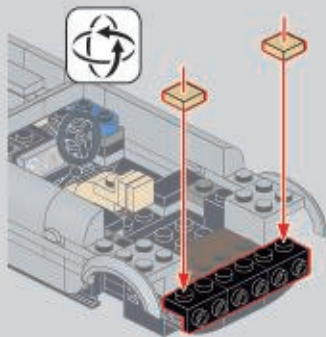

# 49

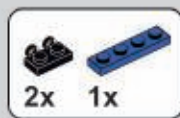
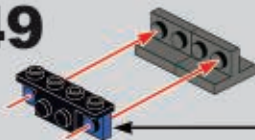

# 50

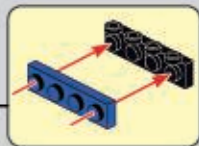
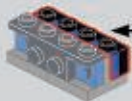

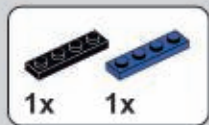

**51**

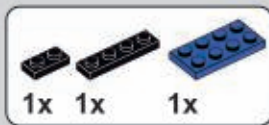
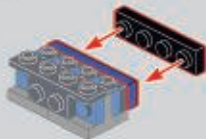

**52**

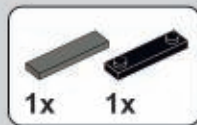

**55**

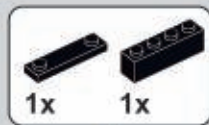
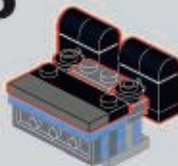

**56**

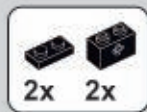
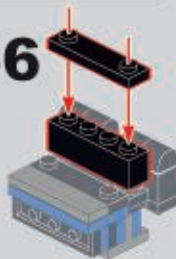

**53**



**54**



**57**

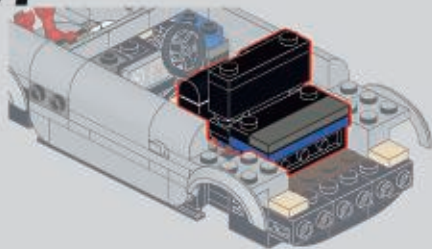



58

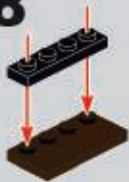

60



59

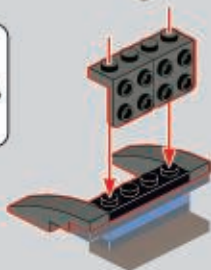

61

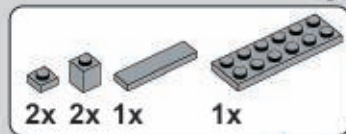
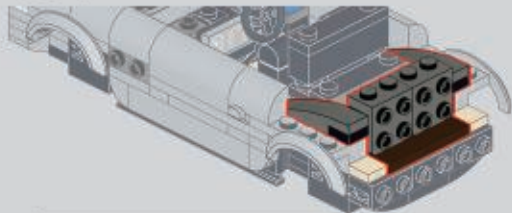

62

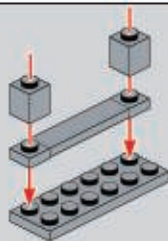

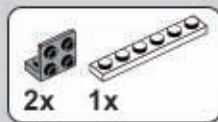

**63**

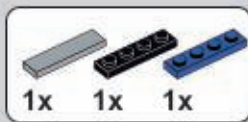
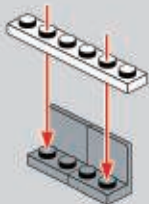

**64**



**65**

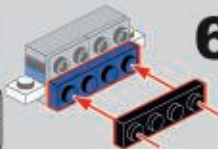

**66**

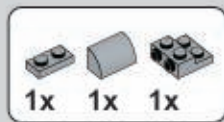

**67**



**69**



**68**

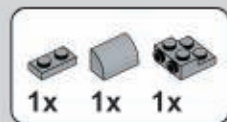
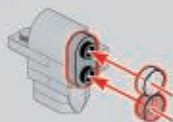

**70**

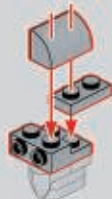



71

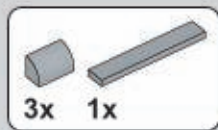
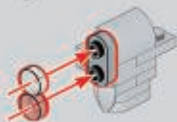

73



62

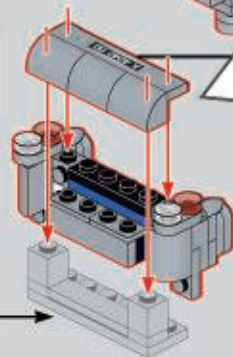

72



68

71

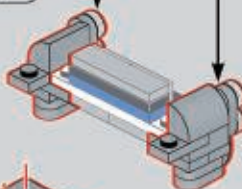

74

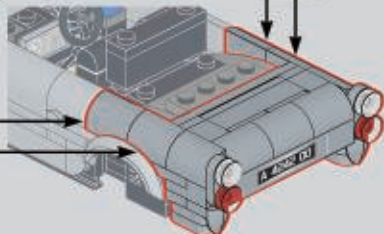

75



76





77



78

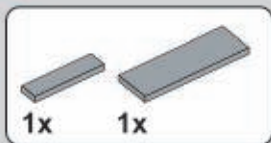

79

77

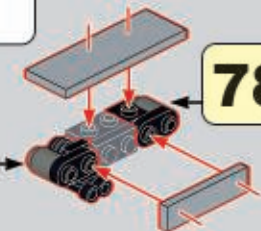

78



80



82



81



83





84



85



86

82

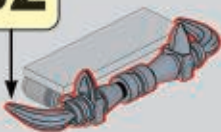

85

87

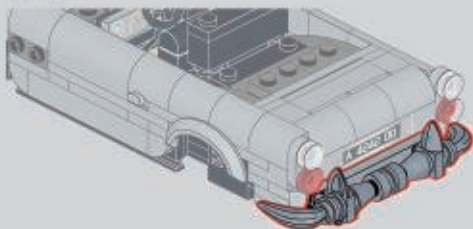

88

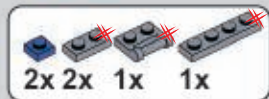
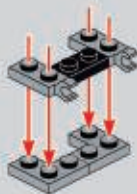

89

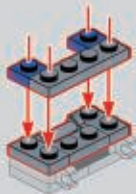



90

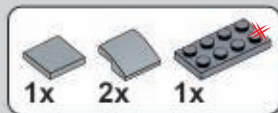
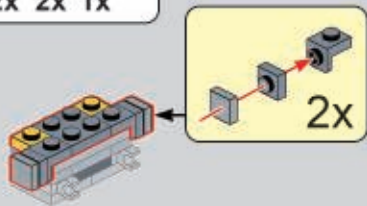

91



92

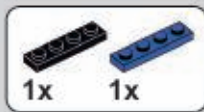
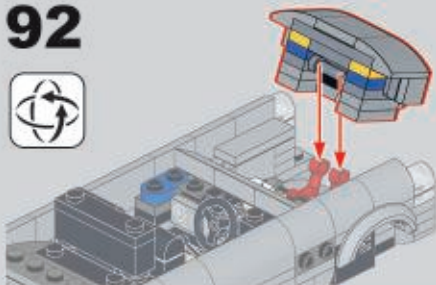

93

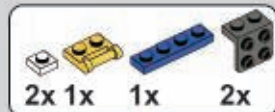

94

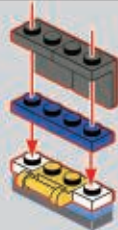

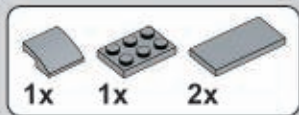

95

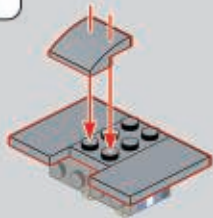

96

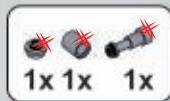
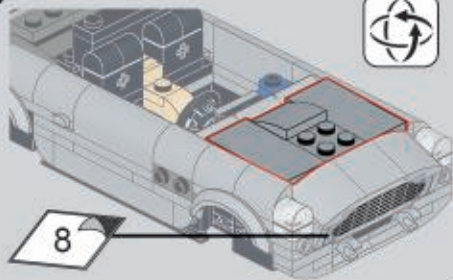

97



98

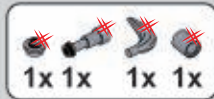

99



# 100

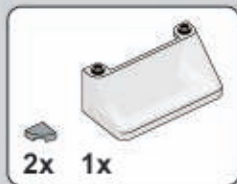
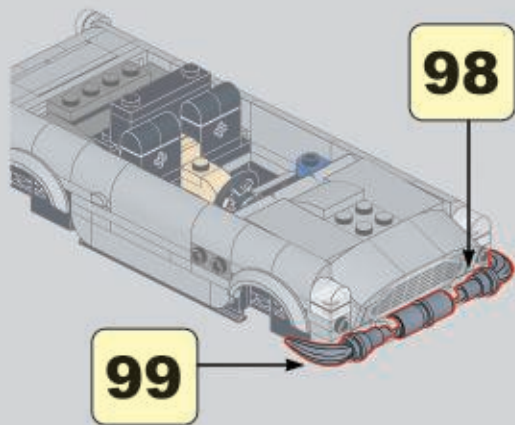

# 101

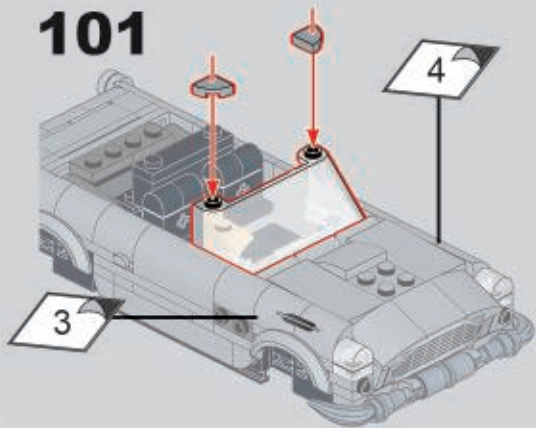

21

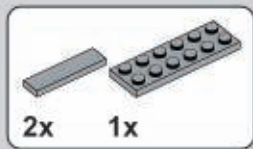

**102**

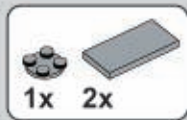
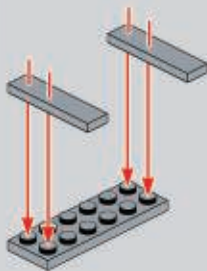

**103**

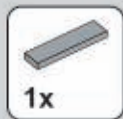
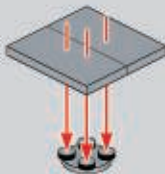

**104**

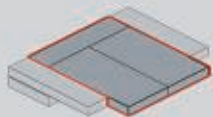

**105**

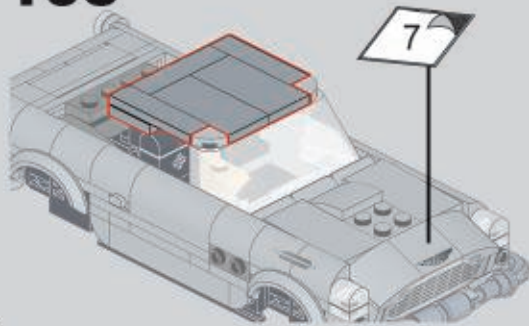

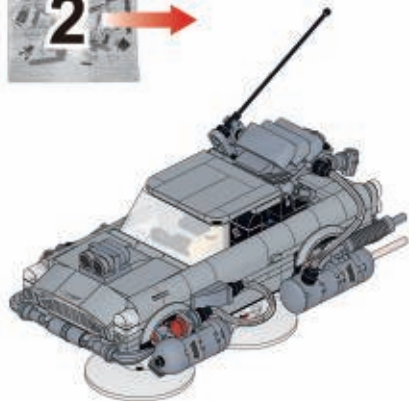

Режим полета  
Ұшу режимі

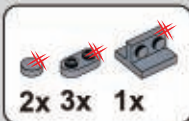

106

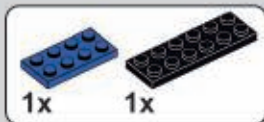
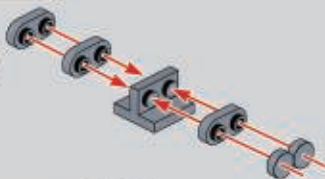

107





**108**

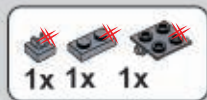
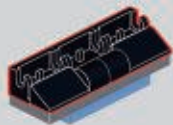

**109**

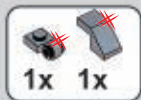
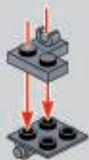

**110**



**111**



**112**



**113**

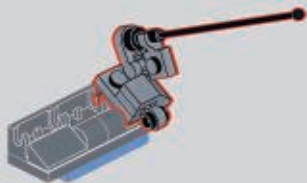

**114**



**115**



**116**

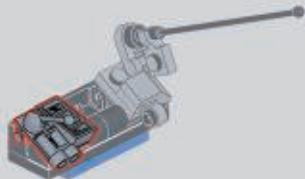

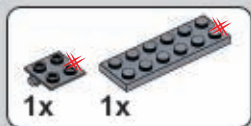

**117**

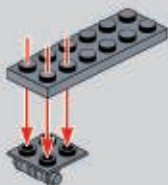

**119**

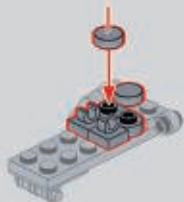

**118**



**120**

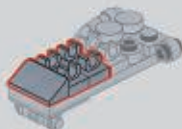

**122**

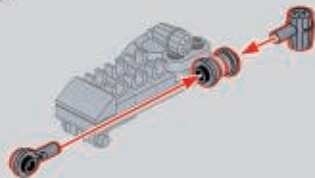

**121**





**123**

**124**

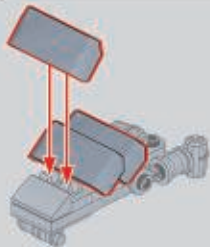
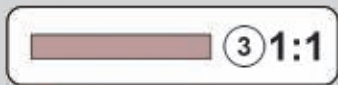

**125**

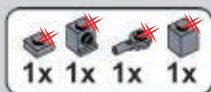

**127**

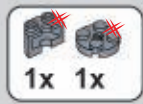

**126**

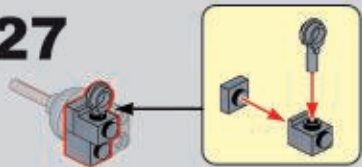
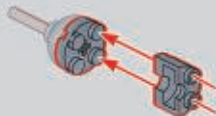
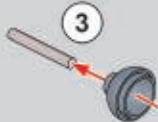

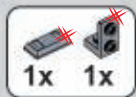

**128**

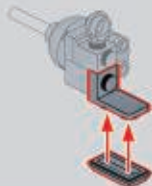

**130**

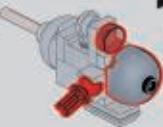

**129**

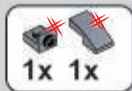
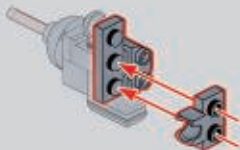

**131**

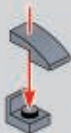

**132**



**133**



**134**



**135**





**136**

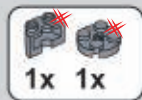

**137**

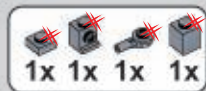
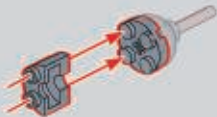

**138**

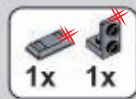
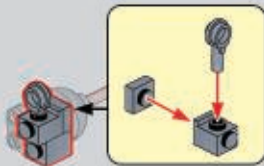

**139**

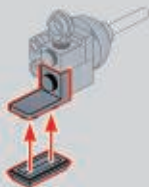



# 140

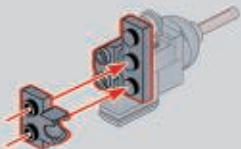

# 141

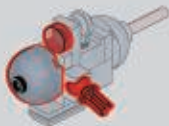

# 142



# 143

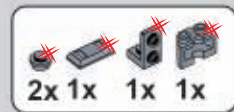
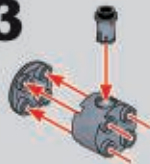

# 144

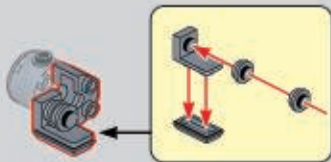



**145**

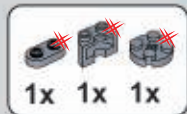
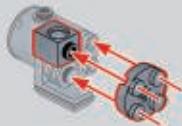

**147**

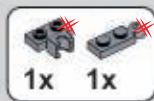
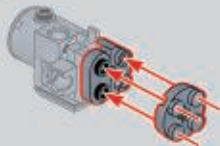

**146**

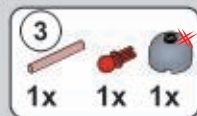
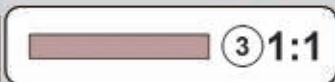
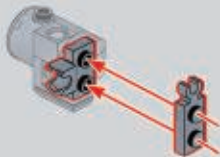

**148**

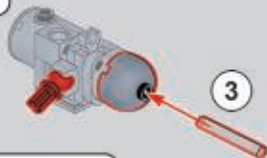

**149**





**150**

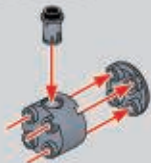

**152**

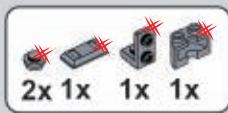
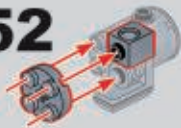

**151**

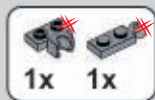
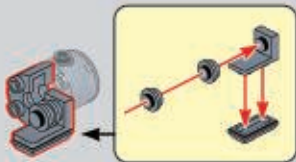

**153**

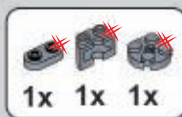
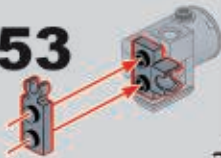

**154**

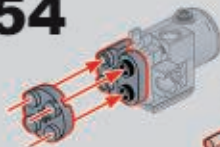

**156**

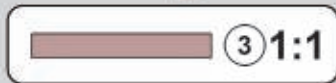

**155**

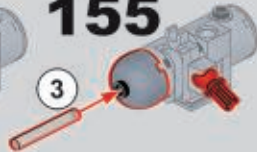

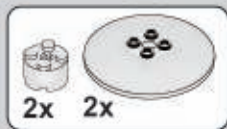

**157**

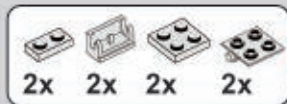
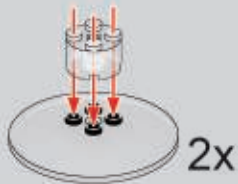

**158**

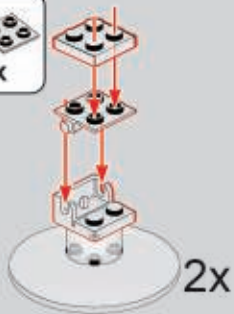

**159**



**124**

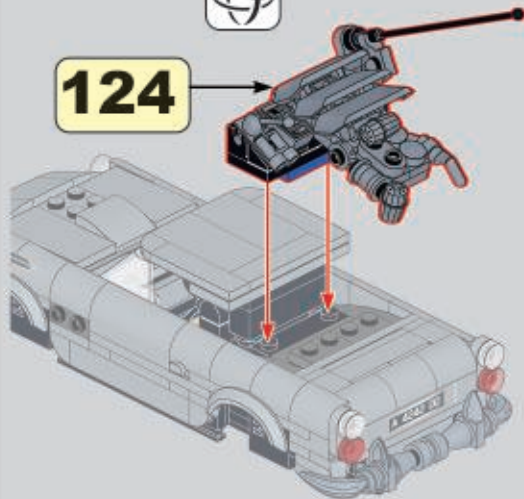

**160**

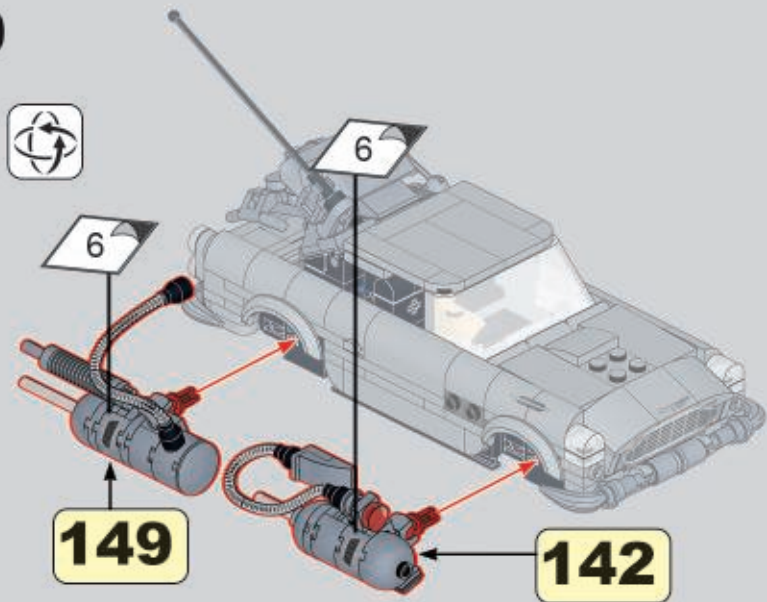

**161**

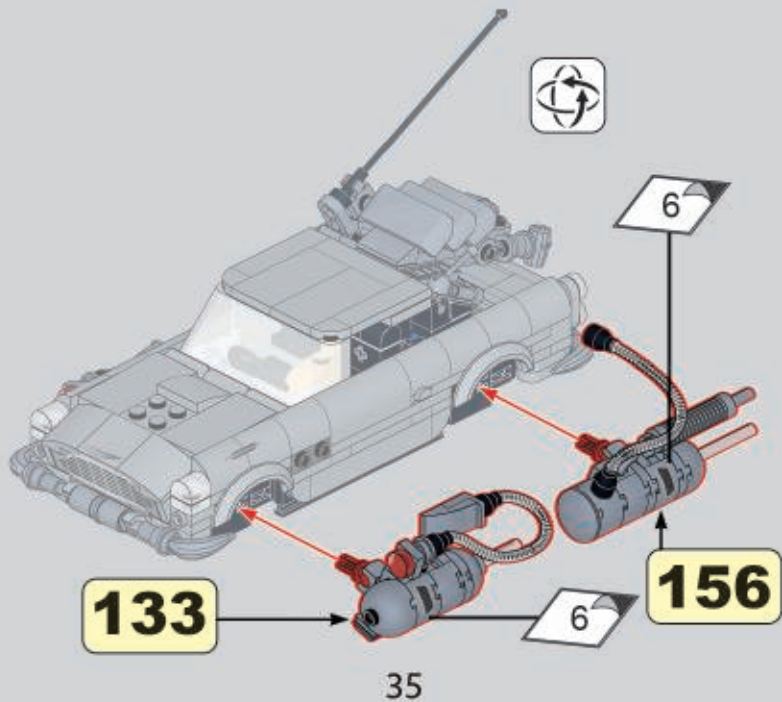

**162**

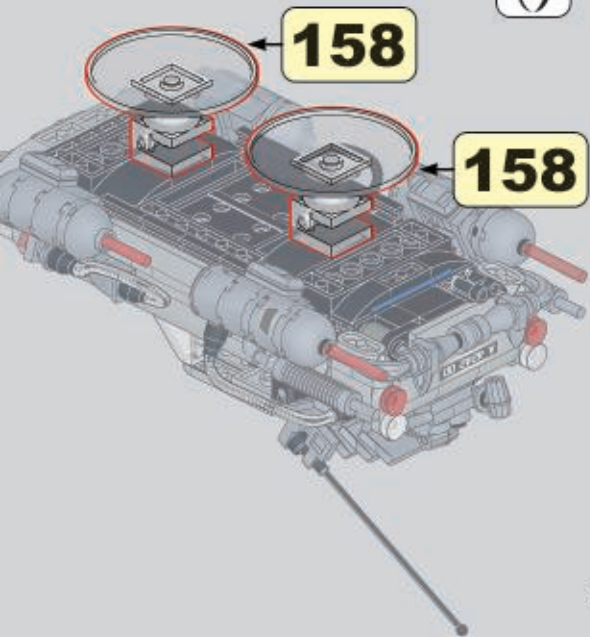

**163**

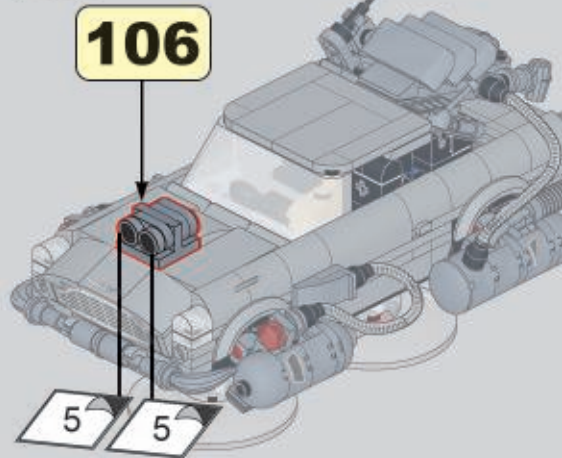

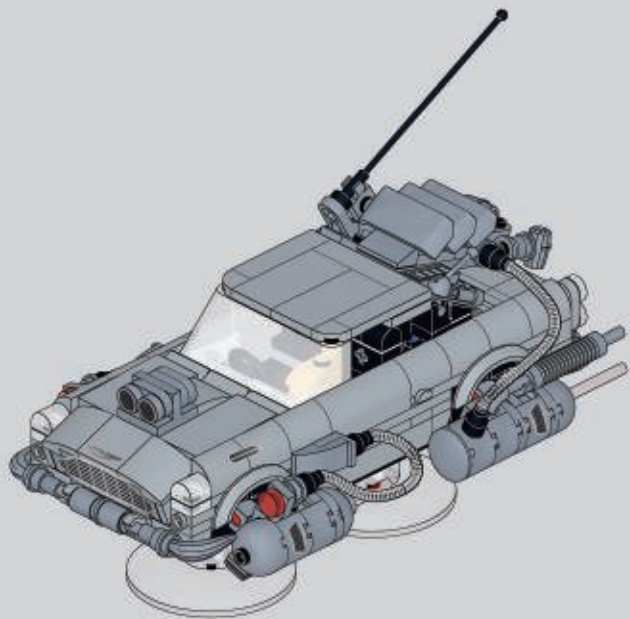

37

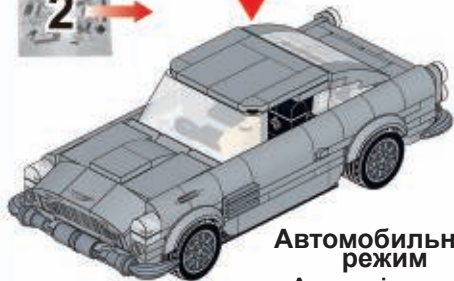
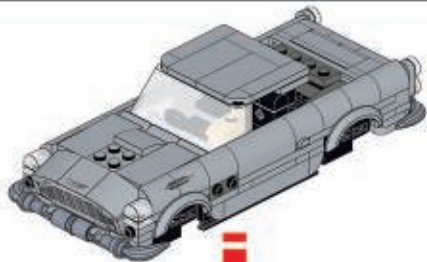

Автомобильный  
режим  
Автокелік режимі



2x 1x

**164**

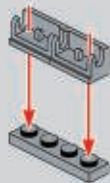

2x

**165**



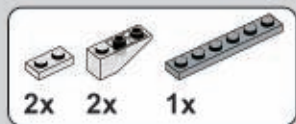

**166**

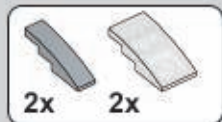
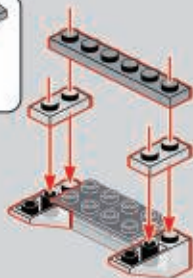

**167**

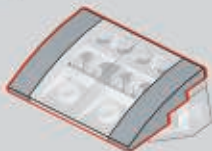

**168**

1



2

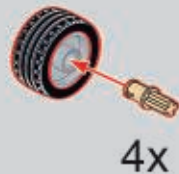

**169**



**167**

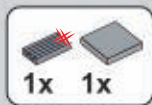
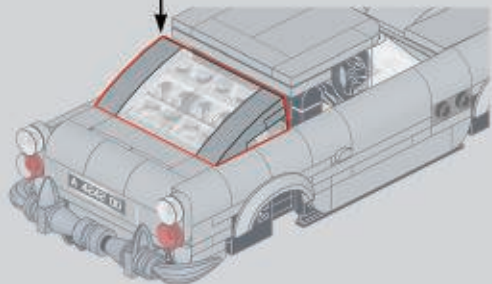

1x 1x

**170**

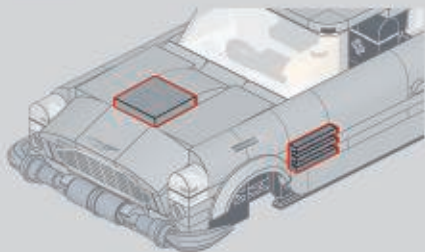



1x



**171**

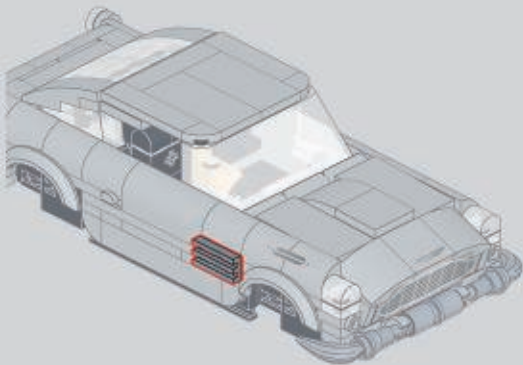

**172**



**168**

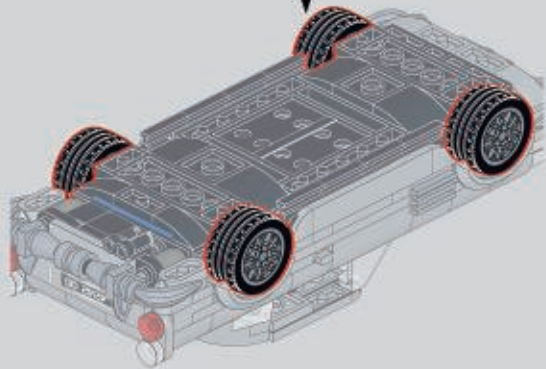



**173**

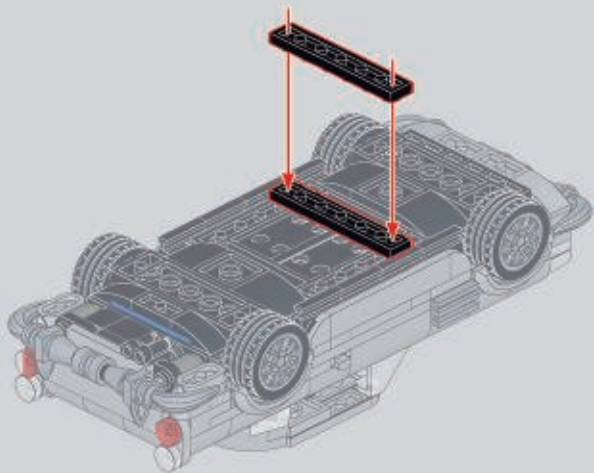



174

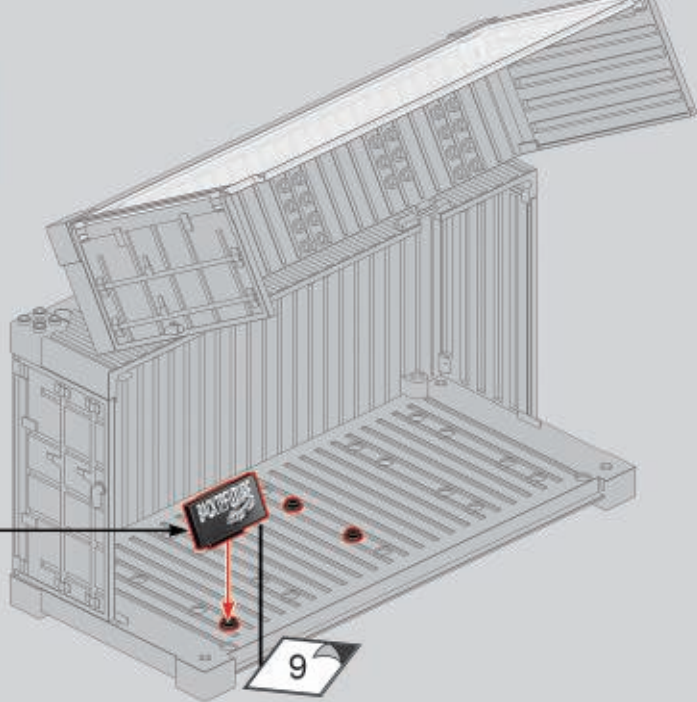
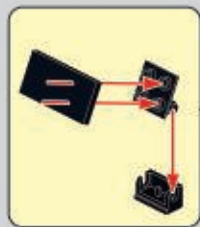

43

175

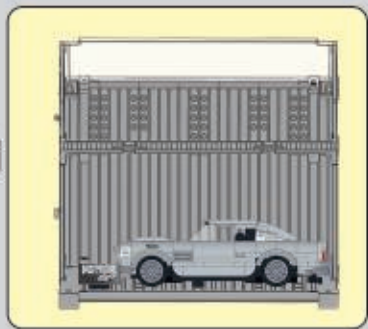
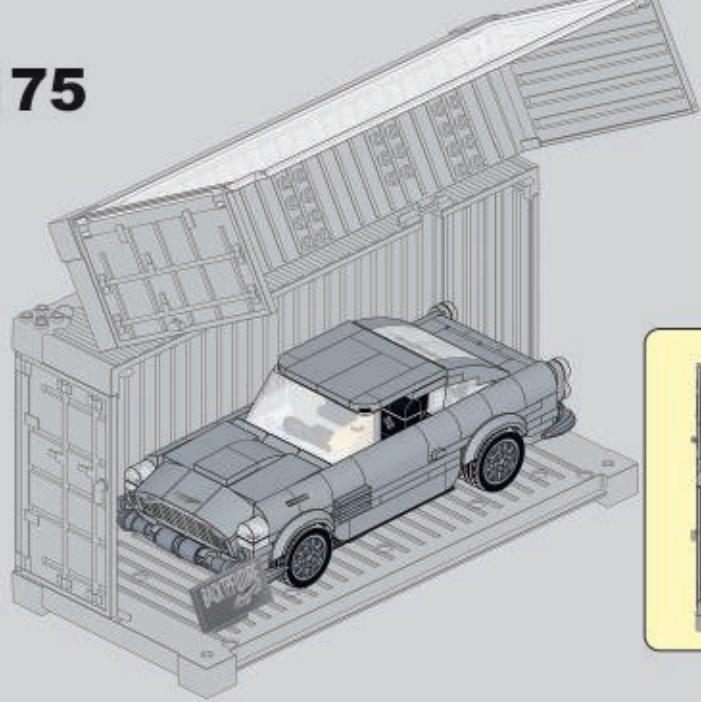

44

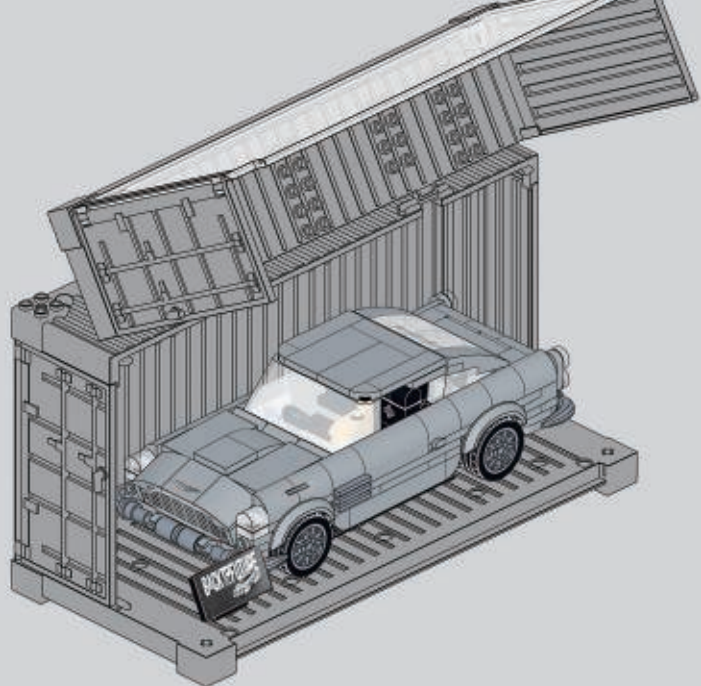

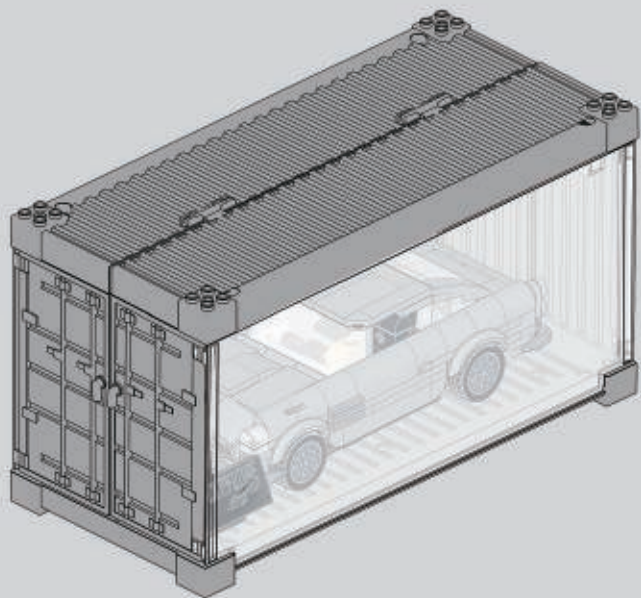





EAC